

DualCompression Hindfoot Nail

Surgical Technique

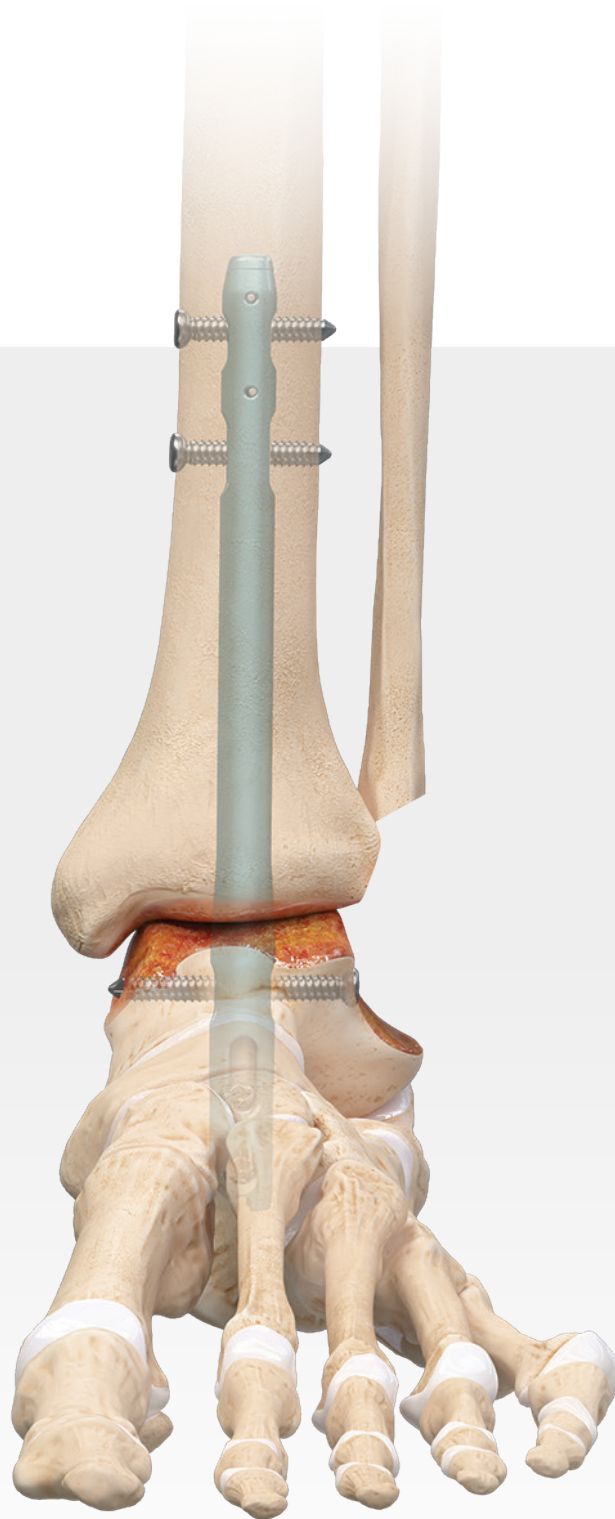

04	DualCompression Hindfoot Nail
04	Introduction
04	Indications
04	DualCompression Internal Compression Mechanism
05	DualCompression Hindfoot Nail Overview
06	Back Table Layout
08	Surgical Technique
08	Quick Guide
10	DualCompression Nail Targeting Guide Overview
11	Patient Positioning
11	Joint Preparation
11	Entry Point Incision
12	Guidewire Placement
13	Entry Reaming
14	Medullary Canal Preparation
15	Targeting Guide Assembly
16	Loading the Tensioning Cable
17	Nail Insertion and Position
18	Screw Insertion Sequence
18	Rotation of the Targeting Guide
18	Distal Calcaneal Screw Placement
20	Distal Tibial Screw Placement
21	Ankle and Subtalar Joint Compression
21	Tensioning the Nitinol Inner Core
22	Proximal Calcaneal Screw Placement
23	Talar Screw Placement (Optional)
24	Proximal Tibial Screw Placement (Optional)
25	Releasing the Cable
25	Releasing the Nail
26	End Cap Insertion (Optional)
26	Final Nail Construct
27	Postoperative Care
27	Nail Removal Information
28	Tray Layout
29	Supporting Products
29	Biologic Augmentation Options
31	Ordering Information
31	Reference

DualCompression Hindfoot Nail

Introduction

Tibiotalar calcaneal (TTC) arthrodesis surgery is performed to relieve pain from arthritic joints and to correct severe hindfoot deformities by immobilizing the ankle and subtalar joints with a functionally stable and plantigrade fusion. The DualCompression Hindfoot Fusion Nail System is designed to provide a streamlined procedure for applying intraoperative compression and sustained dynamic compression.

The stainless steel cable and compression device apply simultaneous axial compression of both joints through the center axis of the nail. Once the tibia, talus, and calcaneus are apposed, the load necessary to stretch the inner nitinol element is applied. The superelastic nitinol inner core of the DualCompression nail provides sustained dynamization after the compression instrumentation is removed¹ and allows for constant compression across both joints during bone resorption or joint settling.

Indications

The DualCompression hindfoot fusion nail implant system is intended to facilitate tibiotalar calcaneal arthrodesis to treat severe foot/ankle deformity, arthritis, instability, and skeletal defects after tumor resection. These include:

- › Neuro-osteoarthropathy (Charcot's foot)
- › Osteoarthritis
- › Avascular necrosis of the talus
- › Pseudoarthrosis
- › Failed joint replacement
- › Rheumatoid arthritis
- › Failed ankle fusion

DualCompression Internal Compression Mechanism

The DualCompression Hindfoot Fusion Nail System creates a stable fusion site by providing two modes of compression for intraoperative and postoperative dynamic compression across both joints.

- › The cable tensions a nitinol inner core. This nitinol core dynamically tensions the construct between the tibial and calcaneal interlocking screws, creating compression across the tibiotalar and subtalar joints postoperatively.



DualCompression Hindfoot Nail Overview

Nail Dimensions

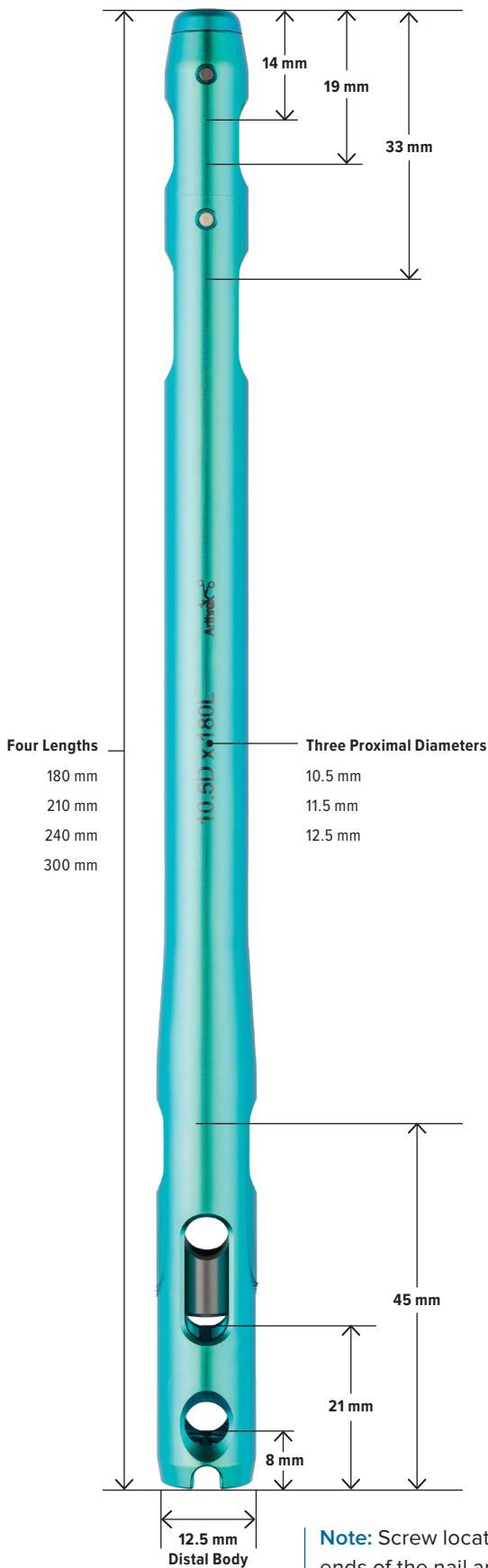

Screws

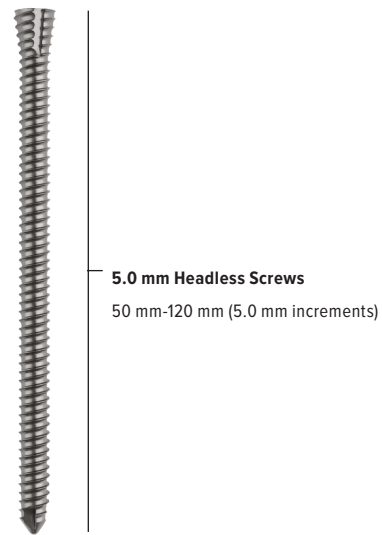
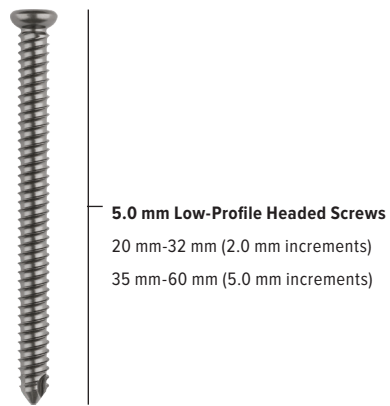

End Caps



Note: Screw locations relative to the ends of the nail are the same for each length and diameter

Back Table Layout

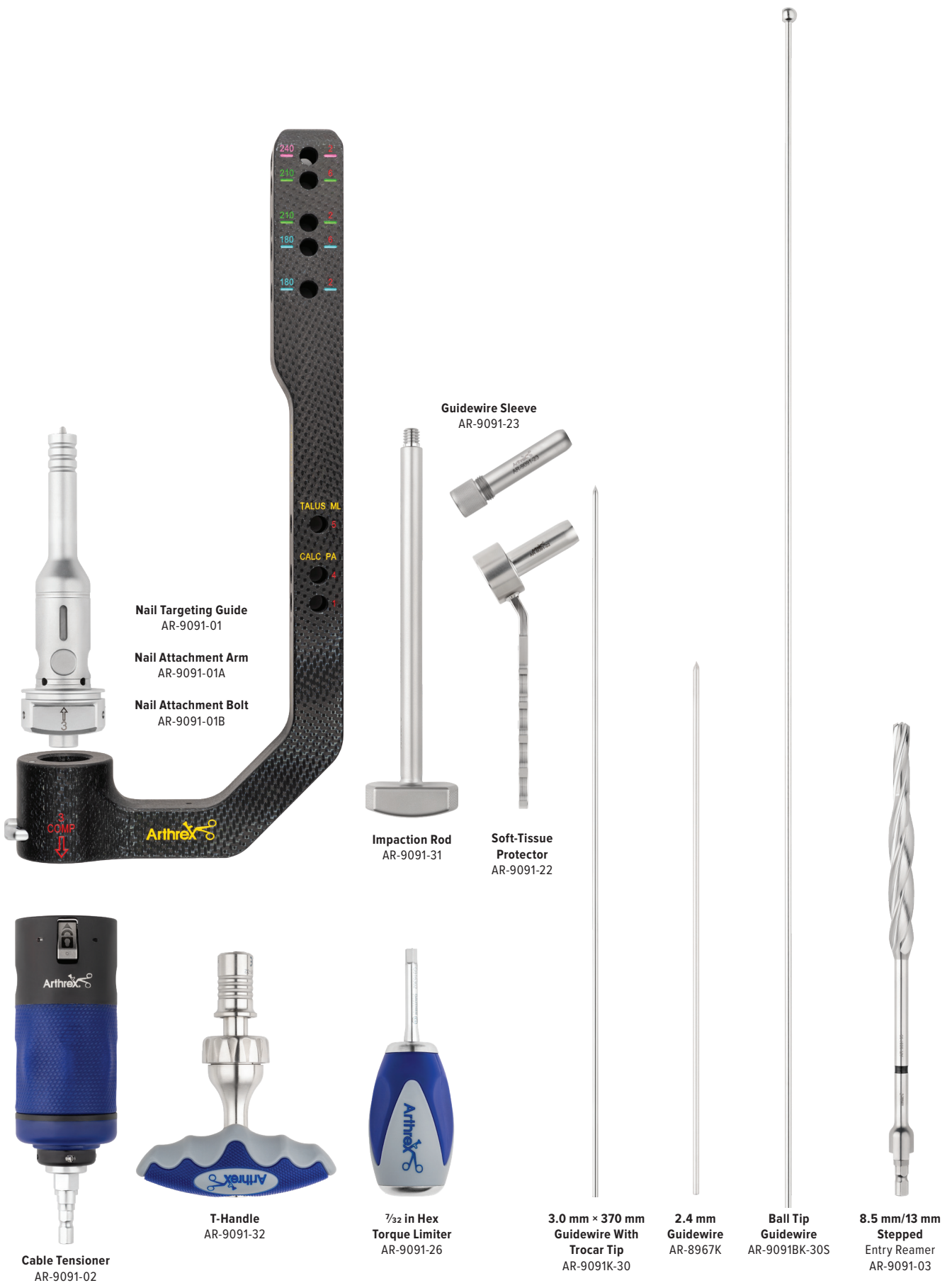

Nail Targeting Guide
AR-9091-01

Nail Attachment Arm
AR-9091-01A

Nail Attachment Bolt
AR-9091-01B

Guidewire Sleeve
AR-9091-23

Impaction Rod
AR-9091-31

Soft-Tissue Protector
AR-9091-22

Cable Tensioner
AR-9091-02

T-Handle
AR-9091-32

7/32 in Hex Torque Limiter
AR-9091-26

3.0 mm x 370 mm Guidewire With Trocar Tip
AR-9091K-30

2.4 mm Guidewire
AR-8967K

Ball Tip Guidewire
AR-9091BK-30S

8.5 mm/13 mm Stepped Entry Reamer
AR-9091-03



**Flexible Reamer
Shaft and Reamer
Cutting Heads**
AR-9091-20
AR-9091-04-13



**AO Ratcheting
Screwdriver Handle**
AR-8970RH



T20 Screwdriver
AR-9091-34



**Calibrated
4.2 mm Drill**
AR-9091-42



Depth Gauge
AR-9091-25

**Tissue Protector/
Screw Guide**
AR-9091-17



**4.2 mm Drill
Sleeve**
AR-9091-18



4.2 mm Trocar
AR-9091-19



Triple Sleeve



**Self-Retaining T20
AO Driver Shaft**
AR-9091-24



6.3 mm Profile Drill
AR-9091-62



**4.2 mm Freehand
Depth Gauge**
AR-9091-28



**4.2 mm
Freehand Drill**
AR-9091F-42



**Self-Retaining
Freehand T20
AO Driver Shaft**
AR-8970-03

Surgical Technique

Quick Guide

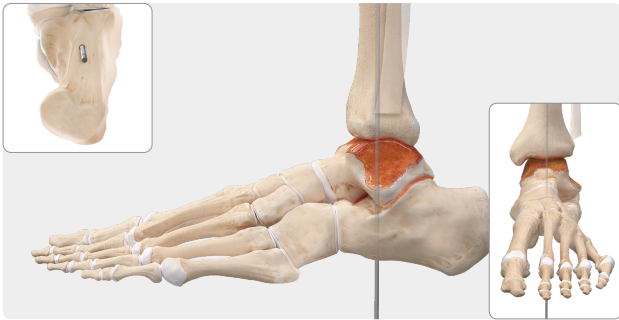

1

Guidewire placement (page 12)



2

Entry reaming (page 13)



3

Medullary canal preparation (page 14)



4

Targeting guide assembly (page 15)

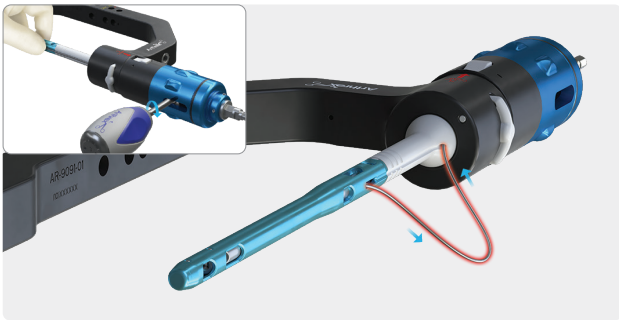

5

Zeroing out tensioner, loosening set screws, removing slack from the cable, and tightening set screws (page 16)

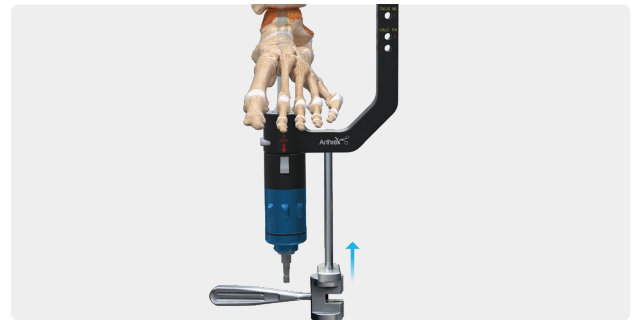

6

Nail insertion (page 17)

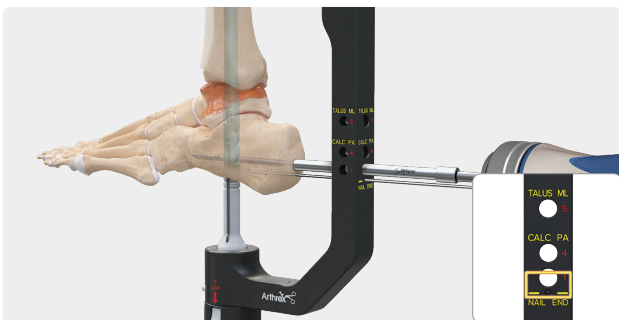

7.1

Distal calcaneal screw (page 18)



7.2

Distal tibial screw (proximal slider) (page 19)



7.3
Ankle and subtalar joint compression (page 21)

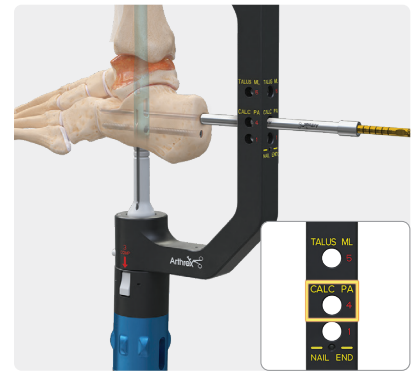

7.4
Proximal calcaneal screw (page 22)

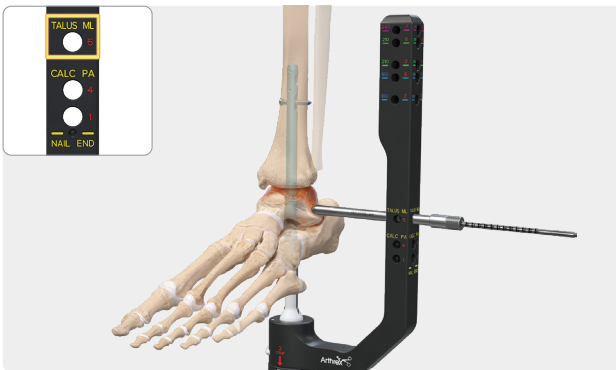

7.5
Talar screw (optional) (page 22)

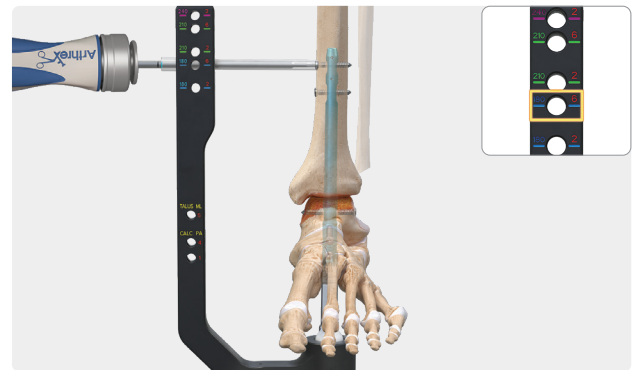

7.6
Proximal tibial screw (optional) (page 24)



8
Releasing the cable (page 25)



9
Releasing the nail (page 25)



10
Inserting end cap (page 26)



11
Final construct (page 26)

DualCompression Nail Targeting Guide Overview

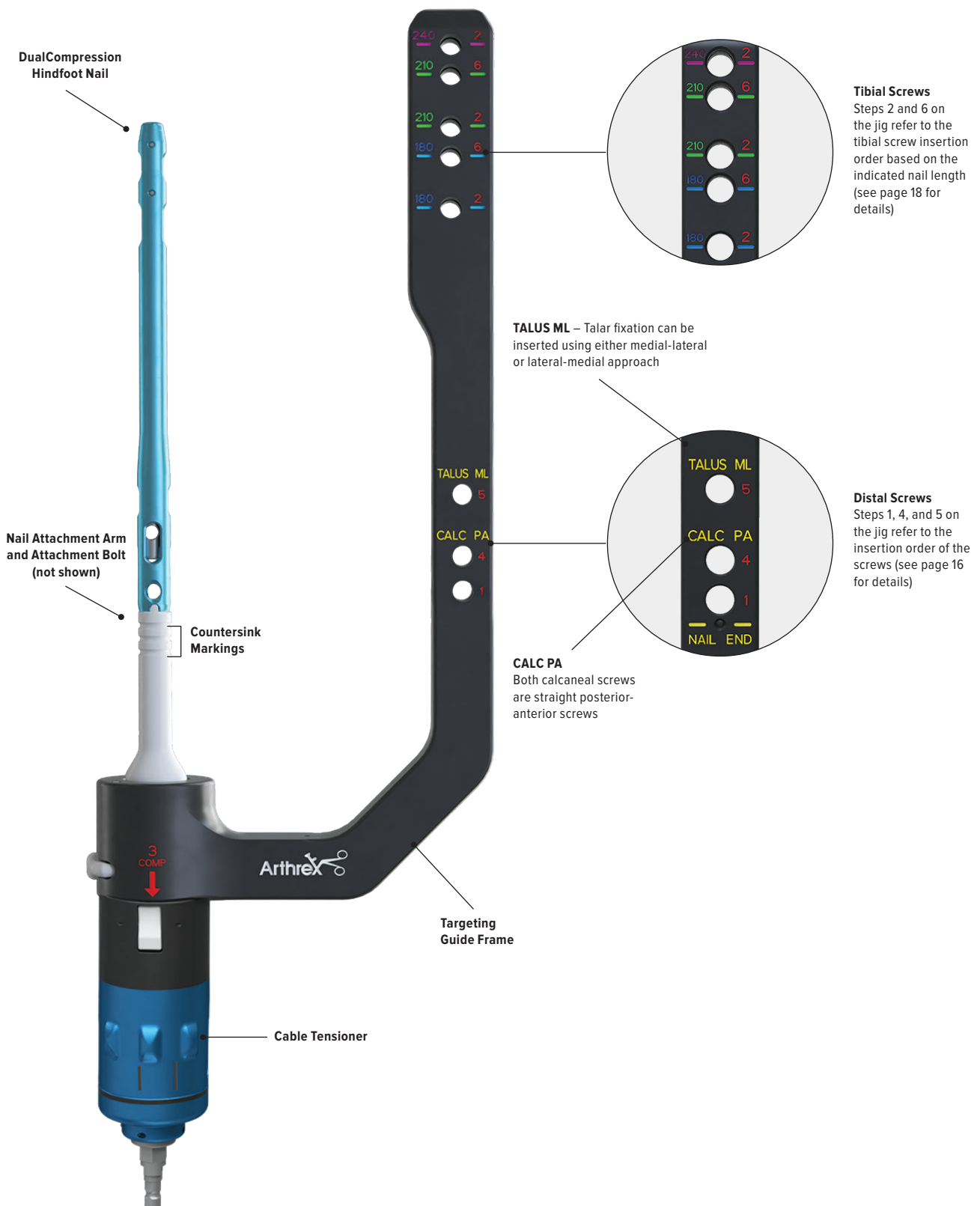

Patient Positioning

Lay the patient supine or prone on a radiolucent table with a bump under the ipsilateral hip to help place the limb in a neutral position. Ensure final positioning facilitates easy AP and lateral fluoroscopy of the foot, ankle, and tibia. Neutral alignment of the ankle and knee should be confirmed throughout the procedure, especially during guidewire insertion and intramedullary reaming.

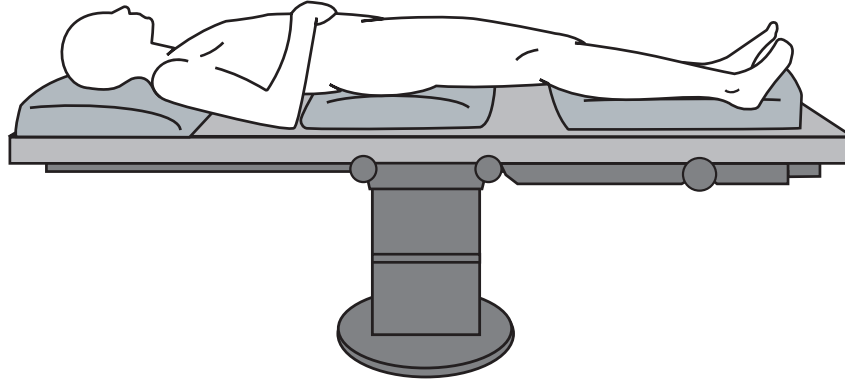

Joint Preparation

Arthritic changes in the ankle may affect patient positioning and surgeon preference for the appropriate approach to joint preparation. Adequate joint preparation and ankle alignment are essential for achieving a successful fusion.

When debriding the tibiotalar and subtalar joints, take care to avoid excessive bony resection, which may result in limb shortening or loss of talar fixation. Depending on preference and approach, the surgeon may elect to resect the fibula.

Place the ankle in neutral dorsiflexion, using the contralateral ankle as a reference for setting the external rotation (5° to 10° is suggested).

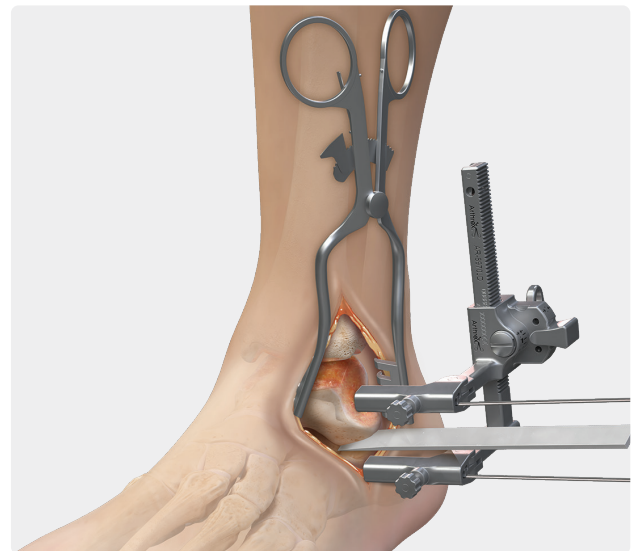

Entry Point Incision

Make a 2.0 cm to 3.0 cm longitudinal incision on the plantar aspect of the heel, anterior to the subcalcaneal fat pad and slightly lateral to the midline. Continue the incision down to the surface of the calcaneus, taking care to protect the neurovascular structures.

1 Guidewire Placement



1a

With the hindfoot in the desired neutral position for fusion, insert the 3.0 mm × 370 mm trocar-tipped guidewire in line with the tibial medullary canal axis. Provisional fixation may be used to maintain joint reduction.

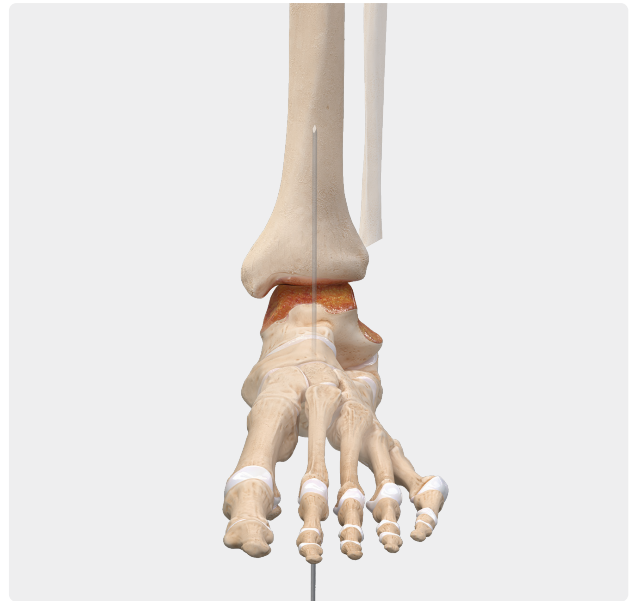

1b

Both AP and lateral fluoroscopic views should be used throughout the guidewire insertion process to ensure proper placement through the center of the calcaneus, talus, and tibial medullary canal.

An axial Harris fluoroscopic view of the calcaneus is recommended to confirm adequate pin placement.

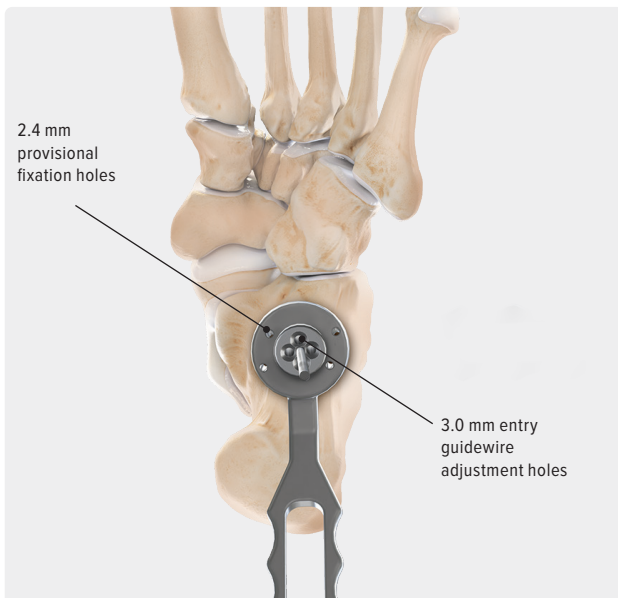

1c

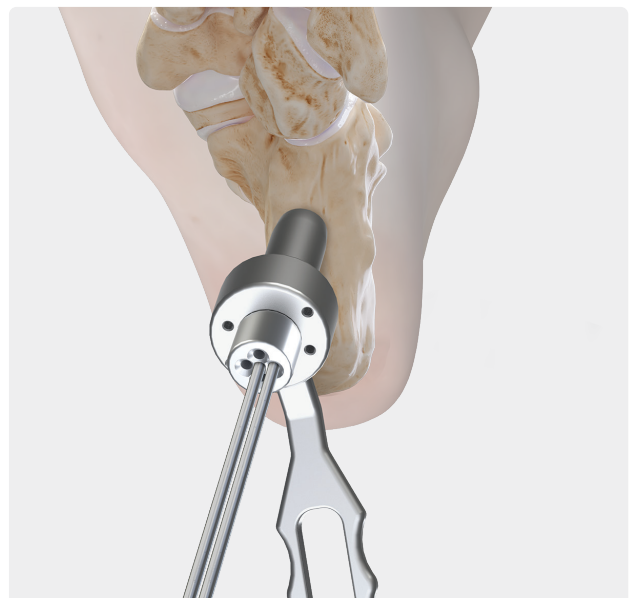

1d

Optional

If needed, use the soft-tissue protector and guidewire sleeve to adjust the guidewire in parallel, 3.5 mm increments in any direction; do not remove the initial guidewire. This helps prevent the guidewire from skiving or following the previously drilled guidewire hole. Do not insert any provisional guidewires into the tissue protector at this time.

2 Entry Reaming



2a

When using the stepped reamer with the soft-tissue protector, advance the reamer through the calcaneus until the depth mark aligns with the distal end of the soft-tissue protector. Use fluoroscopy to ensure the proximal tip of the soft-tissue protector touches the plantar surface of the calcaneus or the depth mark will not align properly.

Note: If the reamer is advancing slowly, cycle the reamer in and out to help clear material from the flutes.

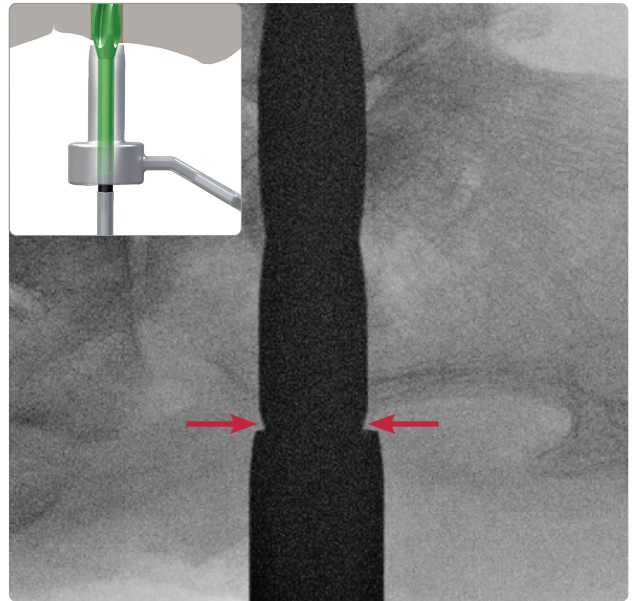

2b

Alternatively, the stepped reamer can be advanced into the calcaneus until the distal end of the reamer (red arrows in figure 2b) is aligned with the plantar border of the calcaneus, as seen under fluoroscopy. The entry reamer matches the shape of the distal portion of the nail. If countersinking the nail, insert the entry reamer past the plantar cortex of the calcaneus and to the desired depth.

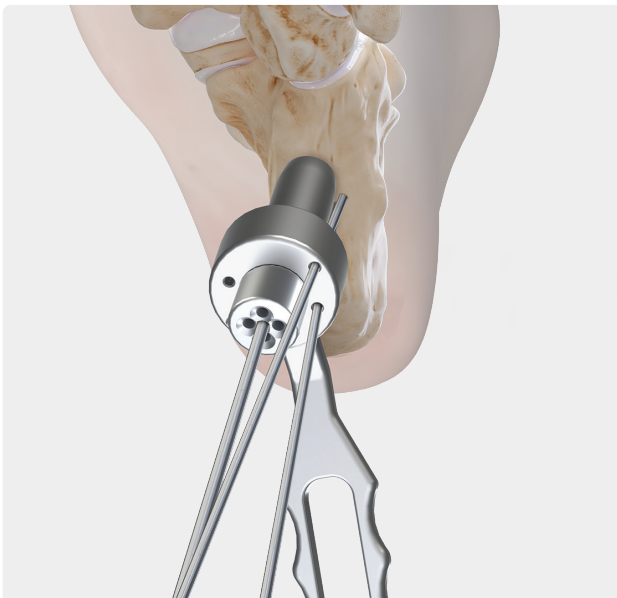

2c

Optional

When using the soft-tissue protector, insert 2.4 mm guidewires through the shoulder of the device into the calcaneus, talus, and tibia while avoiding the central entry guidewire. Align the soft-tissue protector so that the two guidewires are inserted on the lateral side of the calcaneus. This provides provisional fixation and stabilizes the hindfoot while reaming, reducing the likelihood of malalignment during implant insertion after reaming.

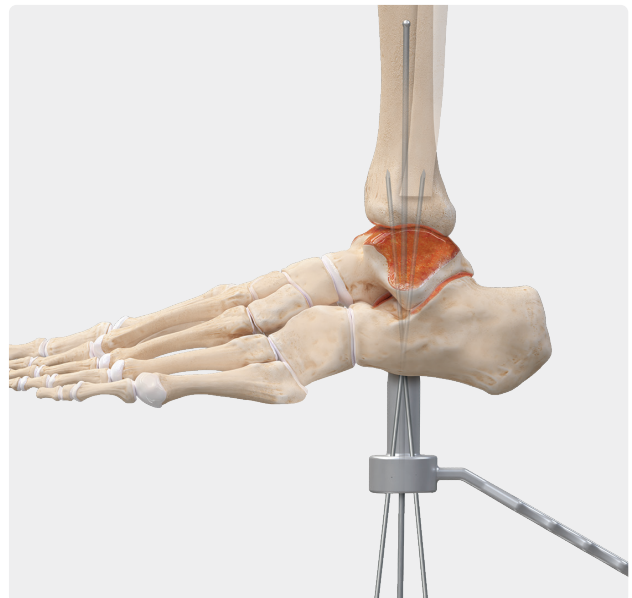

2d

3

Medullary Canal Preparation

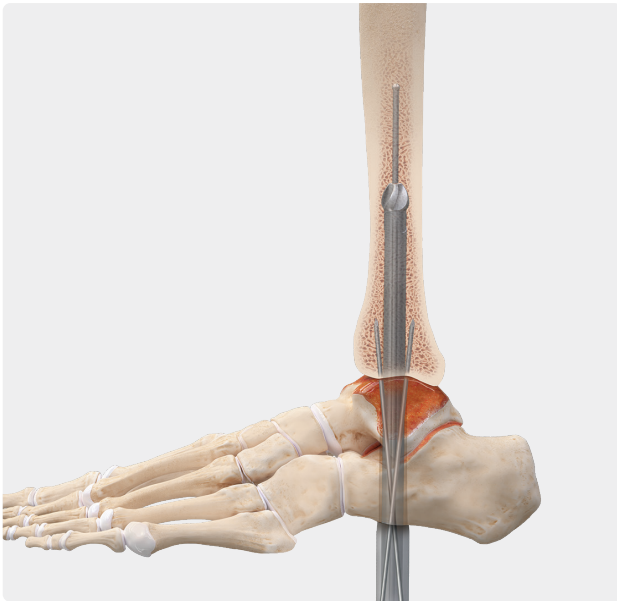

3a

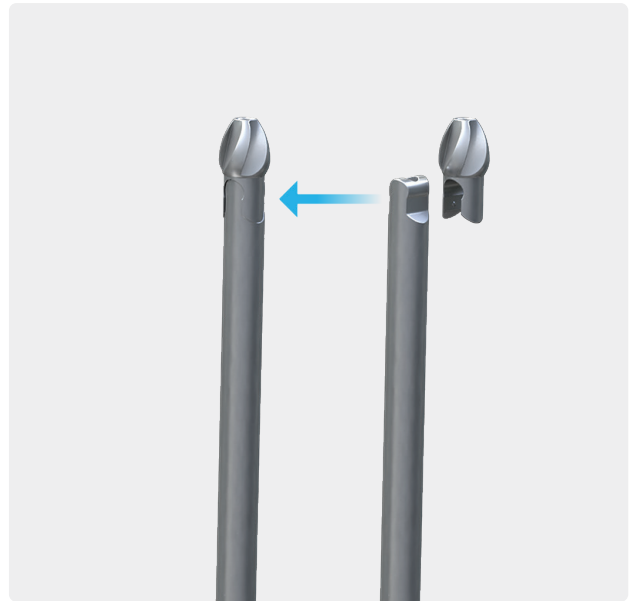

3b

With the soft-tissue protector still in place, remove the 3.0 mm entry guidewire and insert the 3.0 mm ball-tipped guidewire. Attach the end-cutting 9.0 mm reamer head to the flexible reamer shaft.

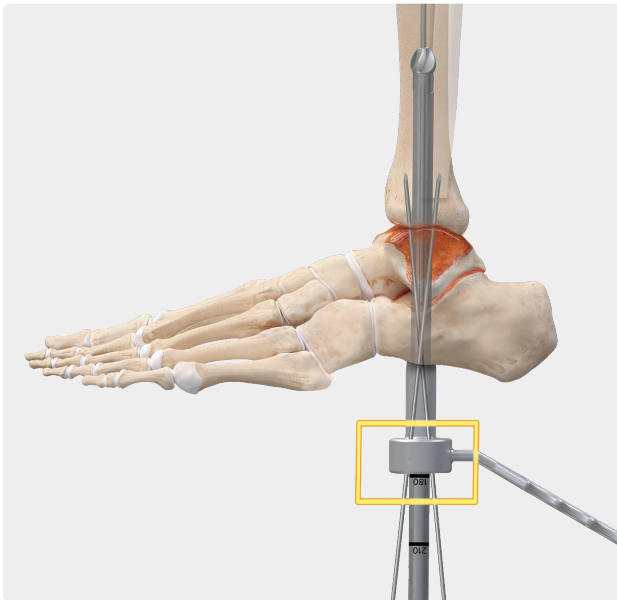

3c

Ream into the medullary canal of the tibia until the desired depth and diameter are reached and confirmed under fluoroscopy. With the soft-tissue protector fully seated on cortical bone, measure the depth using the laser markings on the flexible reamer shaft.

Reaming Tips:

- > The tibial canal should be prepared using sequential reamers until the desired size and depth are reached
- > It is suggested to ream the canal 1.0 mm larger than selected nail size
- > Using the soft-tissue protector and the 2.4 mm provisional fixation guidewires allows for hands-free reaming while holding the ankle joint and hindfoot in the optimal alignment during the entire reaming process

4 Targeting Guide Assembly



4a

Depress the button on the targeting guide frame and insert the nail attachment arm; slide the arm into place until it stops.

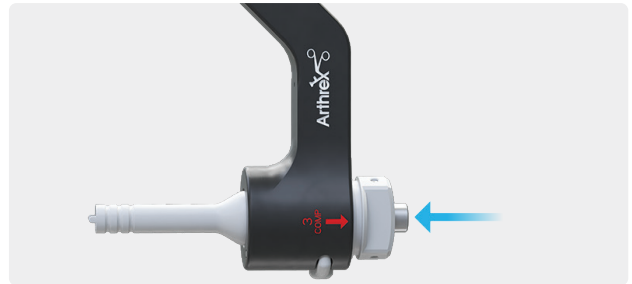

4b

Lay the assembled targeting guide flat on the table and insert the attachment bolt into the attachment arm.



4c

Hold the nail with the tabs on the attachment rod aligned with the slots on the nail. Use the $\frac{7}{32}$ in torque-limiting hex driver to turn the internal threaded rod to secure the nail to the attachment arm.

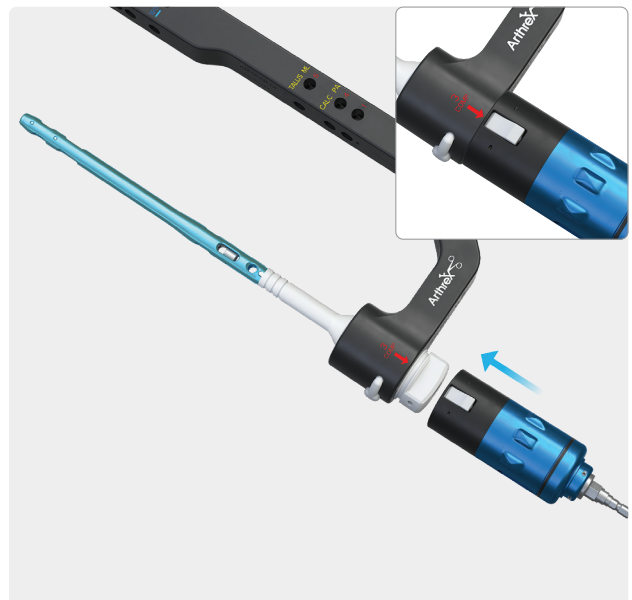

4d

Once the DualCompression nail is attached to the guide, insert the cable-tensioning device until it bottoms out on the targeting guide frame.

Ensure that the arrow marked "3 COMP" is aligned with the attachment button on the cable-tensioning device.

5 Loading the Tensioning Cable



5a

Prior to inserting the stainless steel cable, ensure the set screws on the cable-tensioning device are open and in the starting position.

Note: Lightly tighten the set screws, zero the tensioner by turning the shaft counterclockwise, and fully loosen the set screws.

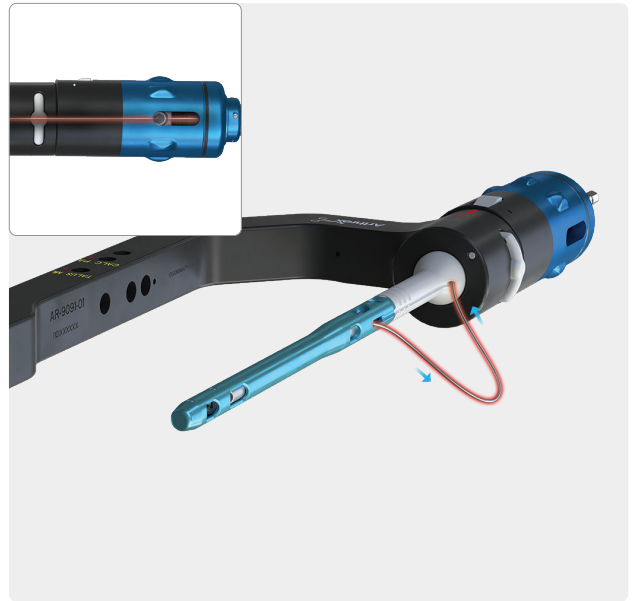

5b

The stainless steel cable has been preloaded through the distal slider in the nail. Starting with one side, insert the cable (shown in red for clarity) into the nail attachment arm until you can see the tail of the cable.



5c

Secure one side of the cable with the torque-limiting hex driver by tightening the set screw in the cable-tensioning device until it clicks three times. Insert the second tail of the cable into the other side of the nail attachment arm.

Prior to tightening the second set screw, remove the slack in the cable by sliding a finger over the cable from the secure end to open the end of the cable, then pinch it on either side of the DualCompression nail to maintain tautness.

Note: Do not turn the tensioning mechanism to remove slack from the cable.

6 Nail Insertion and Position



6a

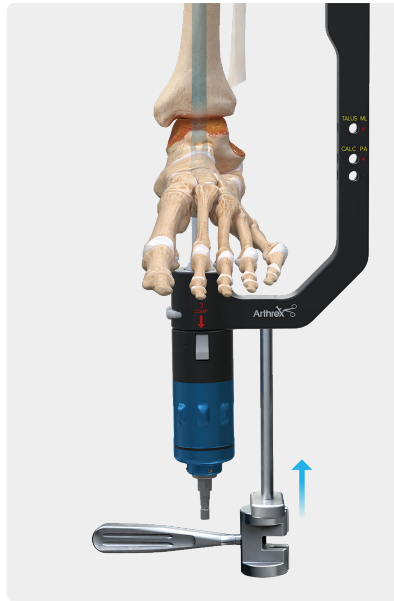

6b

Impaction Tips:

- › Do not strike any other portion of the targeting guide frame or tensioning device aside from the impactation rod
- › Hold the targeting guide frame as a handle during impaction; this is easily done with the frame in the medial or lateral position during implant insertion
- › Ensure the implant rotation is correct after insertion, as internal or external rotation may affect the position and purchase of the calcaneal posteroanterior screws (see step 7)

Remove the ball-tipped guidewire, soft-tissue protector, and any remaining K-wires in the tissue protector. Rotate the targeting guide frame to the medial or lateral side of the foot and insert the DualCompression nail into the medullary canal. Perform the final seating of the DualCompression nail by striking the impaction rod, using the guide as a handle.



6c

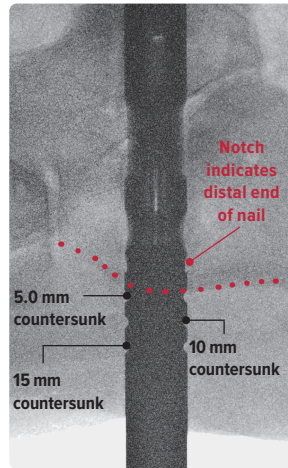

6d

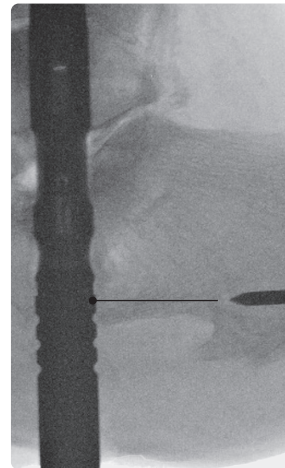

6e

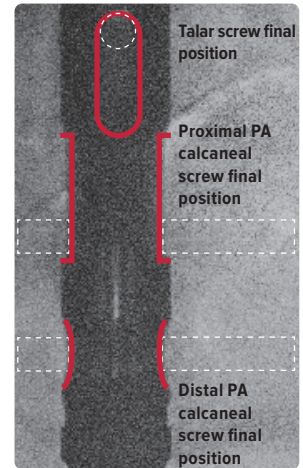

6f

Countersink markings on the targeting guide allow for fluoroscopic verification of the final placement of the nail. The nail features four end cap options: neutral (0 mm), 2.5 mm, 5.0 mm, or 10 mm. Once the desired depth has been achieved, rotate the guide posteriorly (6d).

After rotating the guide posteriorly, the distal end of the nail can be verified by inserting a 2.4 mm guidewire through the "NAIL END" hole marked on the targeting guide (6e).

When countersinking the nail, the location of the proximal PA calcaneal screw should be verified via fluoroscopy so the interlocking screw does not enter the subtalar joint and the drill trajectory has adequate entry and purchase into the tuberosity of the calcaneus (the distal portion of the compression slot should be located just under the subtalar joint line). The top of the talar screw slot can be partially seen prior to the stretching of the nitinol element (6f).

Note: The partially exposed talar screw opening can be used to approximate the final position of the optional talar screw.

7 Screw Insertion Sequence

ROTATION OF THE TARGETING GUIDE



7a

The correct sequence of screw placement is important to achieve compression. The targeting guide includes step numbers to remind surgeons of the correct sequence. The calcaneal screw trajectory should target the length of the lateral calcaneal body to reach but not insult the calcaneocuboid joint. With the targeting guide frame in the posterior position, slightly rotate medially until the calcaneal screw trajectory is aligned with the 4th ray, which will help align the aforementioned screw trajectory. A 2.4 mm pin can be inserted through the “NAIL END” hole to maintain the desired rotation and depth of the nail.

7.1

DISTAL CALCANEAL SCREW PLACEMENT

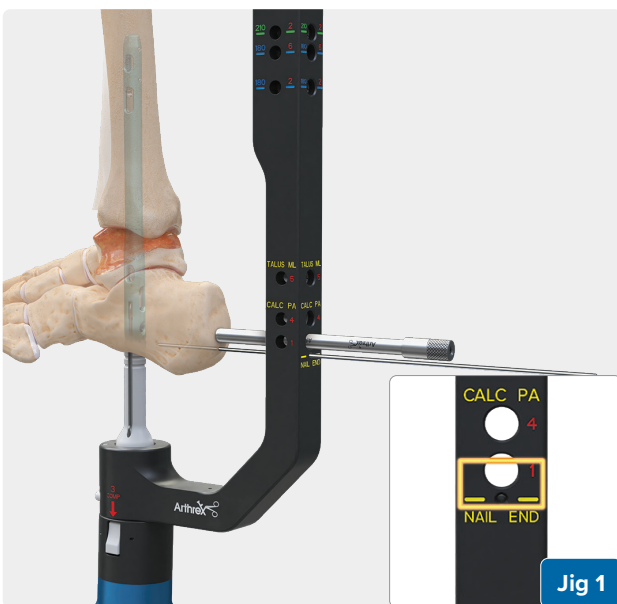

7b

With the targeting arm rotated posteriorly and locked into place, insert the 4.2 mm trocar into the 4.2 mm drill sleeve, then thread into the tissue protection sleeve/ screw guide assembly known as the triple sleeve. Insert the triple sleeve into the most distal PA calcaneus screw hole (see jig 1, inset) and make a stab incision in line with the sleeve assembly. Once the tissue protection sleeve is advanced to the calcaneal cortex, tap the trocar with a mallet, then remove the trocar.

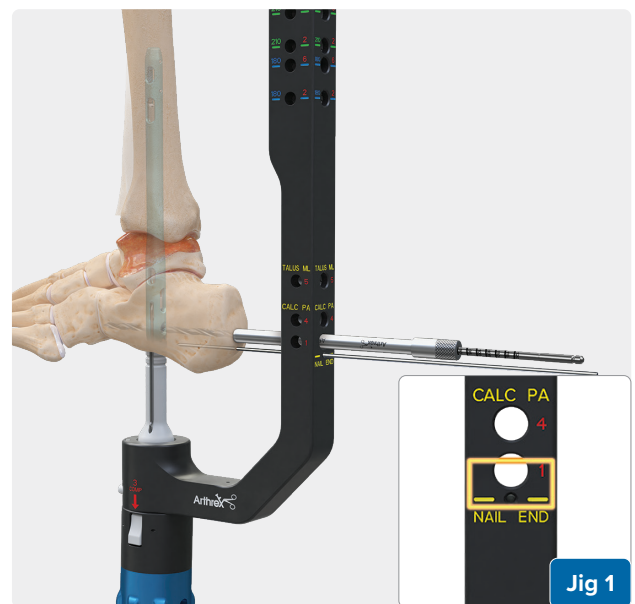

7c

Using the 4.2 mm calibrated drill bit, advance the drill up to, but not into, the calcaneocuboid joint using fluoroscopic guidance. Measure the drill bit off the drill sleeve to ensure the drill sleeve is fully seated on the calcaneal cortex. This screw establishes the rotational location of the nail and acts as the anchor point during joint compression. There are two methods for determining screw length: by the depth markings on the 4.2 mm calibrated drill or using the screw depth-measuring device.

Note: Before removing the drill, use fluoroscopy to confirm adequate drill trajectory in both the sagittal and coronal planes.

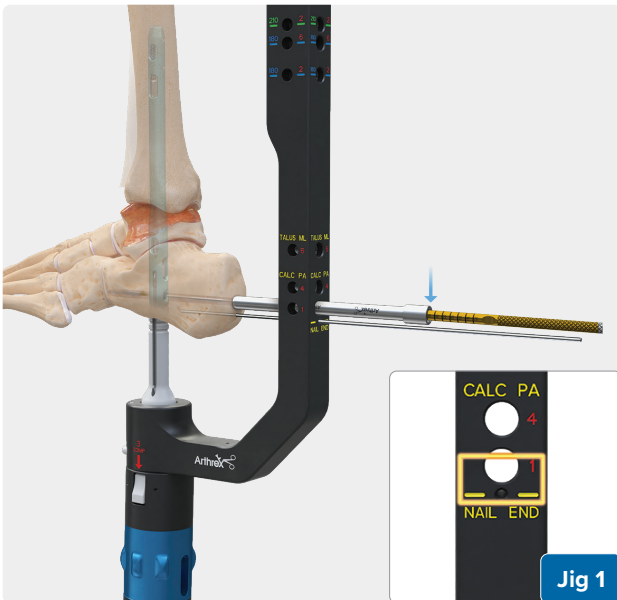

7d

To use the screw depth-measuring device, remove the 4.2 mm drill sleeve from the tissue protection sleeve/ screw guide, then insert the depth device through the sleeve. The dimple on the handle of the depth device indicates which direction the hook tip is pointing. To obtain an accurate measurement, ensure the cannula is seated on the cortical wall of the calcaneus.

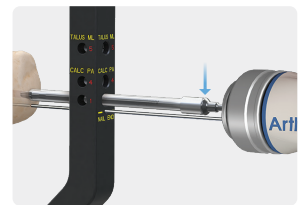
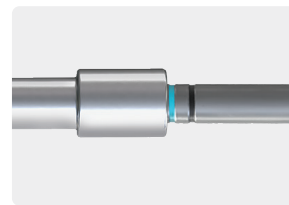
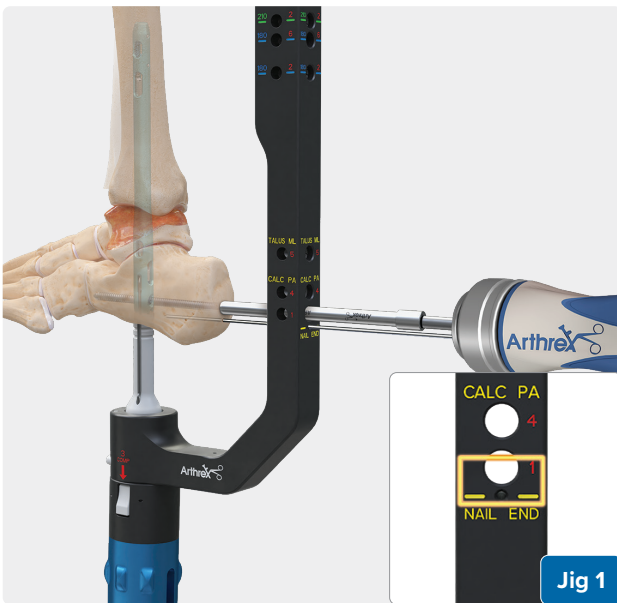

7e

Insert a headless screw of the appropriate length. With the tissue protection sleeve in contact with bone, the black depth marking on the screwdriver indicates the final depth of the screw.

Optional: For hard bone, the 6.3 mm profile drill can be used to prepare the bone for the tapered end of the headless screw.

Note: Ensure screwdriver tip is fully engaged into screw head and axial force is applied during insertion.

7.2

DISTAL TIBIAL SCREW PLACEMENT

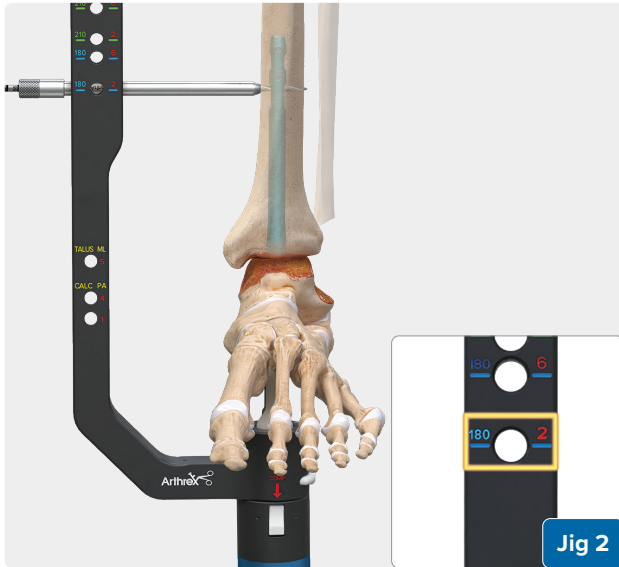

7f

Remove the 2.4 mm pin prior to rotating the targeting guide frame to the medial side and ensure it is locked in place prior to drilling the mediolateral tibial screw. Nail lengths are 180 mm, 210 mm, 240 mm, and 300 mm, and are marked on the targeting guide frame; however, the proximal tibial screw hole on the 240 mm nail and both 300 mm tibial nail screw holes are not present (see note in 7g). Prior to drilling, confirm the triple sleeve is inserted in the correct hole of the targeting guide frame.



7g

For a 180 mm DualCompression nail, the tissue protection sleeve/screw guide should be inserted in the hole marked 180 – 2.

Note: Both tibial screws for the 300 mm DualCompression nail and the proximal tibial hole on the 240 mm nail must be placed freehand using the “perfect circle” technique found on page 22.

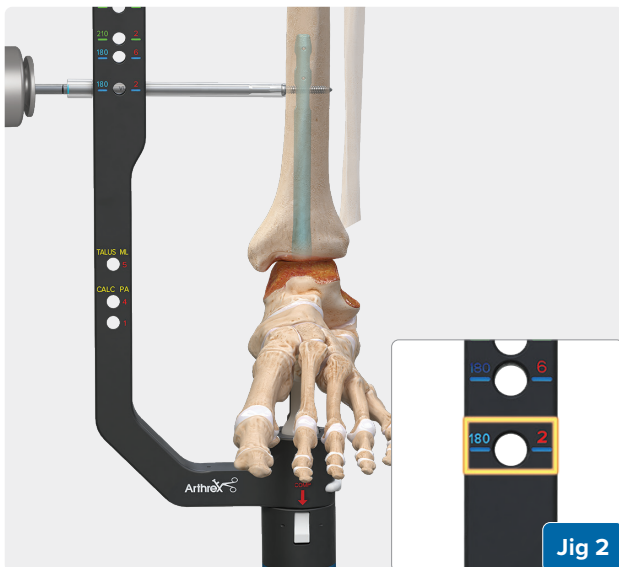

7h

Insert the 4.2 mm drill and drill bicortically. Read the laser markings on the drill relative to the back of the drill guide, or use the screw depth-measuring device to determine the appropriate headed screw length.

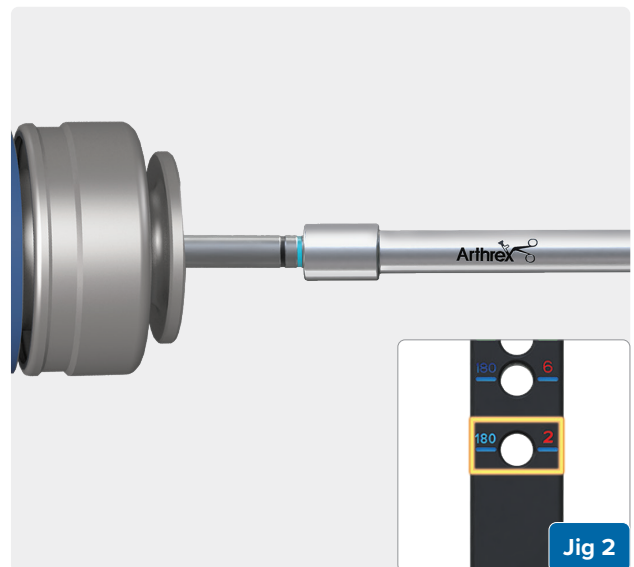

7i

The screw is near the proper insertion depth when the groove around the shaft of the T20 driver is near the end of the tissue protection sleeve/screw guide. STD (for standard cortical screw, shown in blue) represents the insertion depth for standard cortical screws; HDLS (for headless screw, shown in black) represents the depth for headless screws.

7.3

ANKLE AND SUBTALAR JOINT COMPRESSION

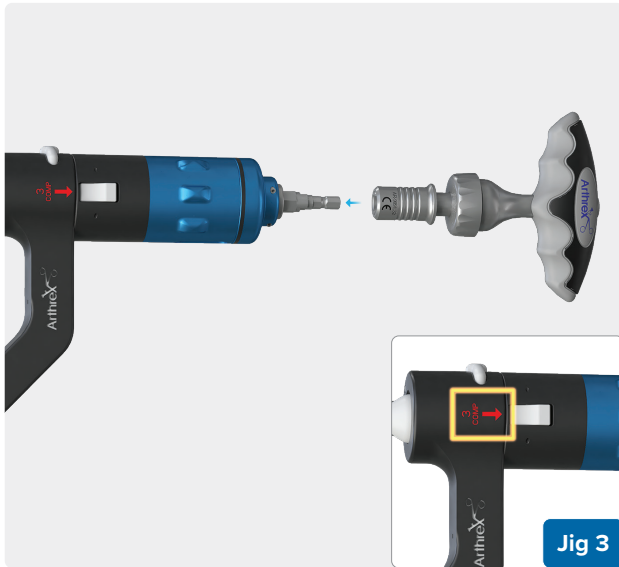

7j

With the distal tibial screw in place, remove any remaining provisional pin fixation and connect the T-handle to the cable tensioner to tension the stainless steel cable (marked with “3 COMP” on the guide).

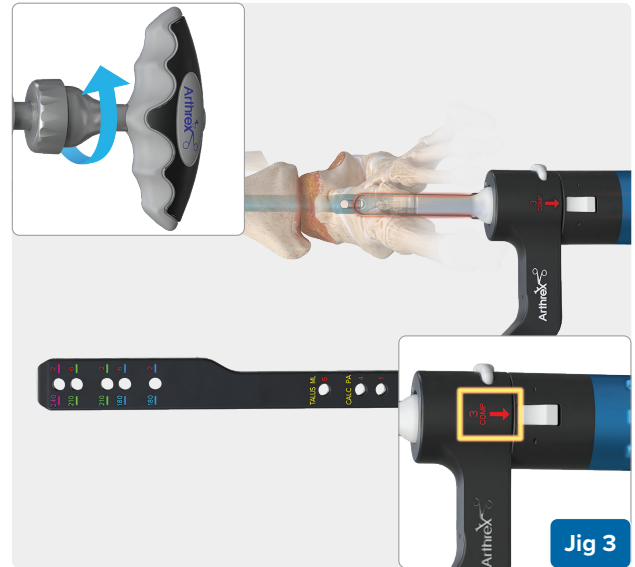

7k

This tensioning creates axial compression through the center axis of the nail, resulting in simultaneous compression of the tibiotalar and subtalar joints. Tighten the T-handle to mechanically compress the joints until the handle can no longer turn.

TENSIONING THE NITINOL INNER CORE

The second mode of compression within the DualCompression System is dynamic compression created by the superelastic nitinol core. Once the bones are apposed, the tensioner stretches the superelastic nitinol element. This nitinol inner core provides dynamic compression during bone resorption or joint settling and maintains compression across the tibiotalar and subtalar joints.



7l

Turn the T-handle on the cable-tensioning device until the hard stop of the device is reached. This ensures that the nitinol core is fully stretched and the distal slider is seated in the correct position.

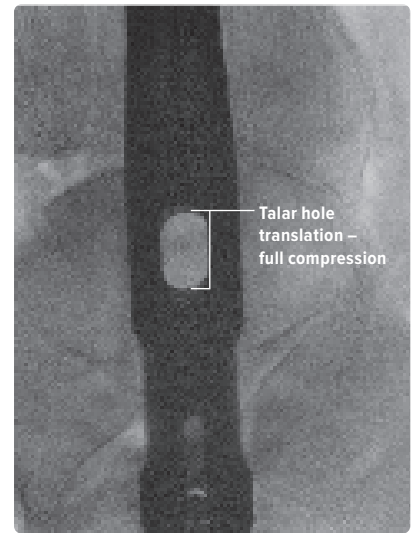
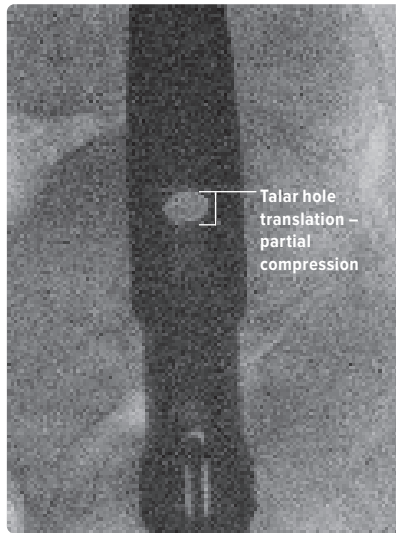
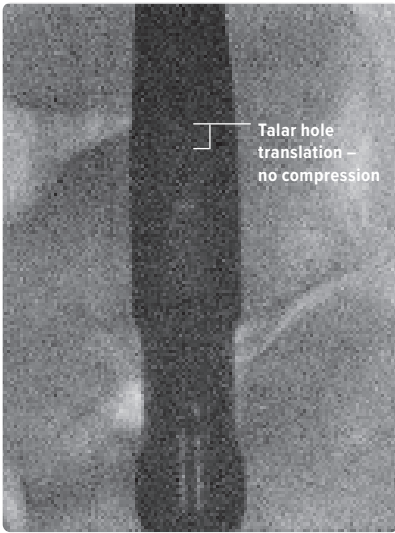

When the joint is compressed and the superelastic nitinol core is fully stretched, the talar screw slot is visible.

7.4

PROXIMAL CALCANEAL SCREW PLACEMENT

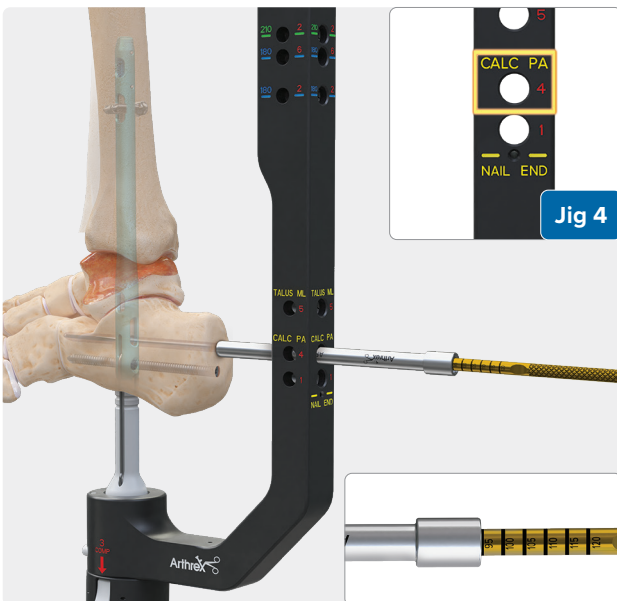

7m

With the cable-tensioning device still attached to the targeting guide, remove the T-handle from the tensioner.

Rotate the targeting guide frame to the posterior side of the ankle and ensure it is locked in place prior to drilling the superior PA calcaneal screw (marked on the guide as #4).

Insert the triple sleeve into the superior PA calcaneal screw hole and make a stab incision in line with the sleeve assembly. After advancing the tissue protector to the calcaneal cortex, tap the trocar with a mallet, then remove the trocar. Insert the 4.2 mm drill and drill to the desired depth, ensuring the drill does not violate the calcaneocuboid joint. Read the laser markings on the drill relative to the back of the drill guide or use the screw depth-measuring device to determine the appropriate headless screw length.

Note: Before removing the drill, use fluoroscopy to confirm adequate drill trajectory in both the sagittal and coronal planes.

Ensure screwdriver tip is fully engaged into screw head and axial force is applied during insertion.

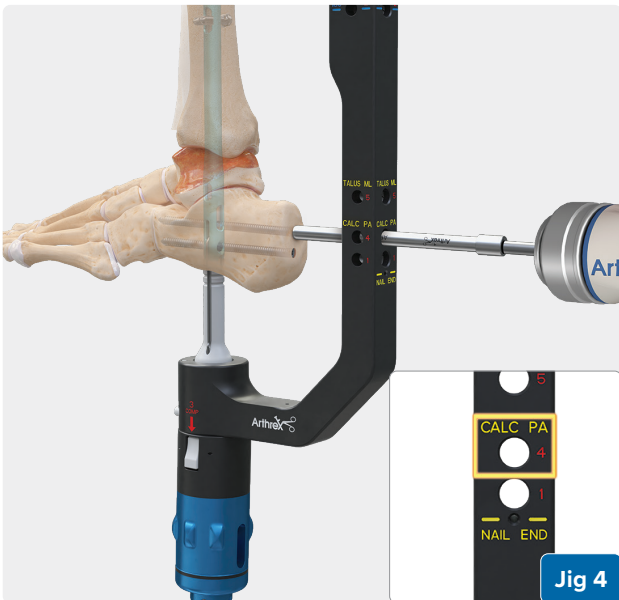

7n

With the nitinol core activated, the second PA calcaneal screw locks the distal slider.

7.5

TALAR SCREW PLACEMENT (OPTIONAL)



7o

Rotate the targeting guide frame to the lateral side and ensure it is locked in place prior to drilling the lateral-to-medial talar screw (marked on the guide as #5). Insert the triple sleeve into the talar screw hole (marked #5) and make a stab incision in line with the sleeve assembly. Once the tissue protector is advanced to the talar cortex, tap the trocar with a mallet, then remove the trocar.

Note: If the fibula was NOT osteotomized, proceed with optional talar screw placement using a medial approach.



7p

Insert the 4.2 mm drill and drill bicortically. Read the laser markings on the drill relative to the back of the drill guide or use the depth gauge to determine the appropriate headed screw length. Next, insert the headed talar screw using the STD (blue) depth line on the screwdriver.

Note: Before removing the drill, use fluoroscopy to confirm adequate drill trajectory in both the sagittal and coronal planes.

7.6

PROXIMAL TIBIAL SCREW PLACEMENT (OPTIONAL)

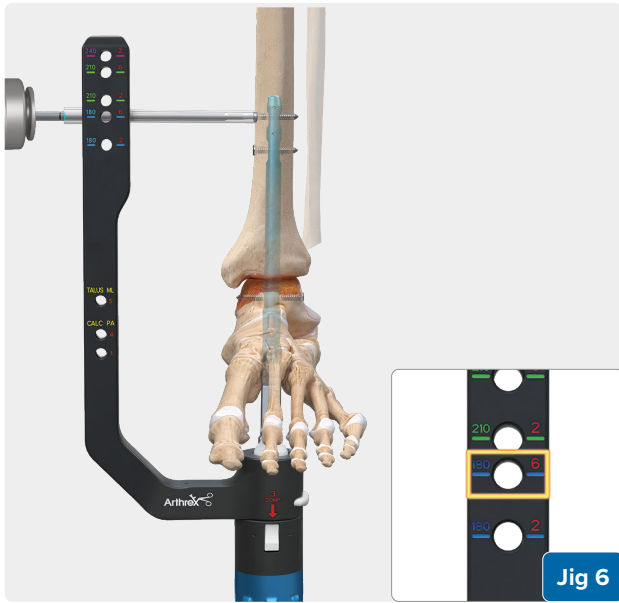

7q

Rotate the targeting guide frame to the medial side of the ankle and ensure it is locked in place before drilling the proximal medial to lateral tibial screw. Prior to drilling, confirm the triple sleeve is inserted in the correct hole of the targeting guide frame (marked #6). Read the laser markings on the drill relative to the back of the drill sleeve to determine the appropriate screw length.

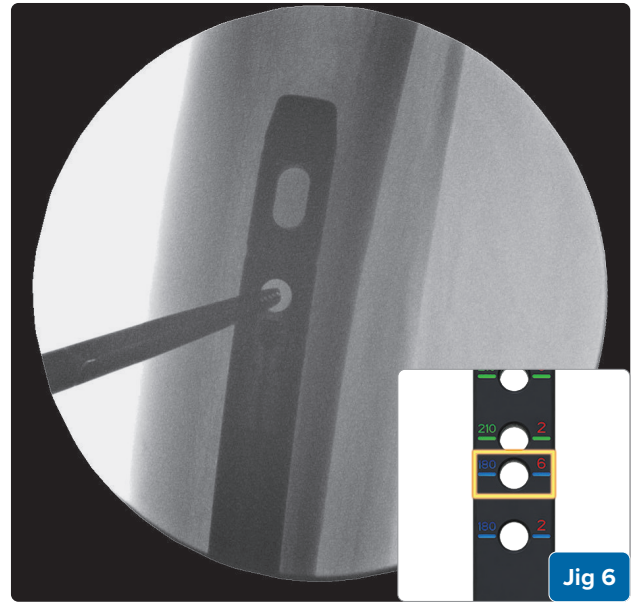

7r

240 mm and 300 mm nails only: For 240 mm nails, the most proximal tibial fixation will need to be inserted freehand into the tibial hole. For 300 mm nails, both tibial screws (holes 2 and 6) must be placed freehand under fluoroscopic guidance.

A freehand 4.2 mm drill, freehand screw depth gauge, and freehand T20 driver allow for shorter working lengths when inserting the proximal tibial fixation for both 240 mm and 300 mm DualCompression nails. The proximal headed tibial screw is placed in the proximal aspect of the dynamic slot, allowing for maximum compression.

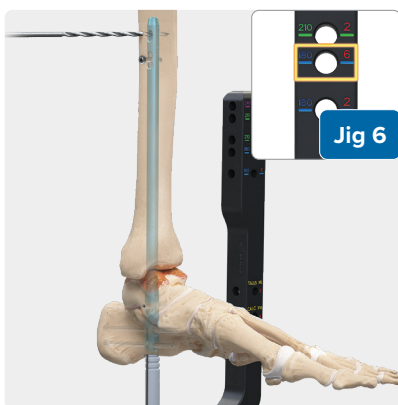

7s

Use the freehand 4.2 mm drill to drill for the proximal screw.

Note: Before removing the drill, use fluoroscopy to confirm adequate drill trajectory in both the sagittal and coronal planes.



7t

Use the freehand depth gauge to measure the appropriate screw length.



7u

Use the freehand screwdriver to insert the appropriate screw.

8 Releasing the Cable



8a

With the targeting guide frame on either the medial or lateral side, loosen **only one** of the cable retaining set screws on the cable-tensioning device with the $\frac{7}{32}$ in hex torque limiter.



8b

Using the cable-tensioning device as a handle, remove the cable from the nail by pulling until the cable is completely free of the construct.



8c

Once removed, release the cable from the other side of the cable-tensioning device and dispose of the cable.

Note: Never reuse the stainless steel cable, and treat the used cable as a sharp instrument.

9 Releasing the Nail



9a



9b

Once the stainless steel cable and cable-tensioning device are removed, use the $\frac{7}{32}$ -inch hex torque-limiting driver to release the nail from the targeting guide.

10 End Cap Insertion (Optional)

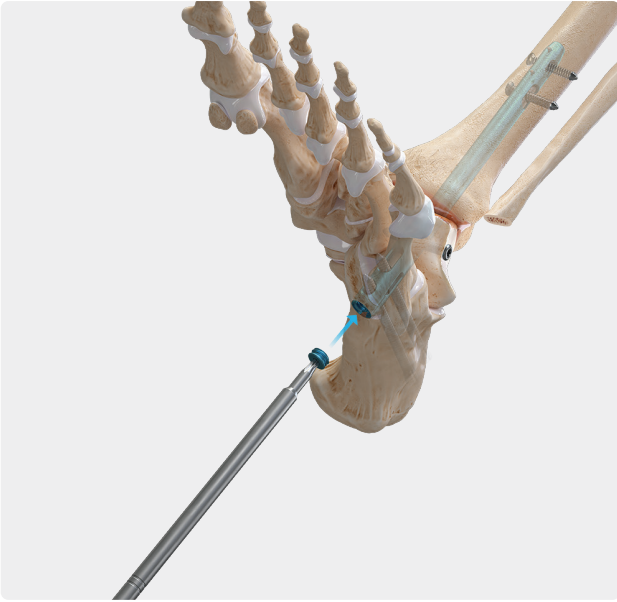

10

The end cap is offered in multiple lengths—0 mm, 2.5 mm, 5.0 mm, and 10 mm—depending on how far the nail is countersunk in the calcaneus. Using the T20 hexalobe driver, advance the preferred end cap into the distal threads of the DualCompression nail.

End Cap Benefits:

- > Prevents bony ingrowth and soft-tissue obstruction into the DualCompression nail's internal threads, allowing for easier future removal
- > Protects distal end of the nail and surrounding soft tissue

11 Final Nail Construct



11a

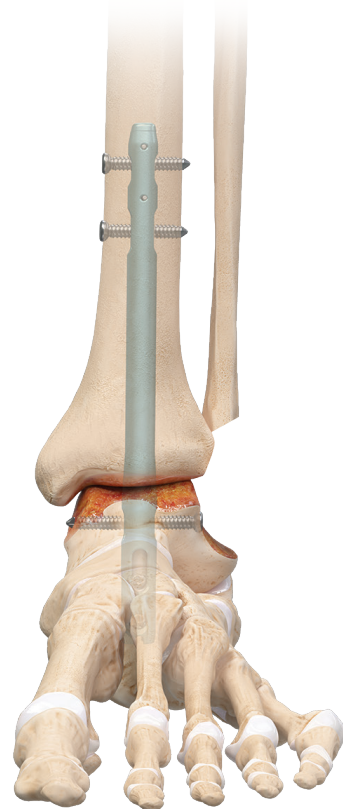

11b

Postoperative Care

Nail Removal Information



12

The T20 hexalobe driver can be used to remove the end cap and all interlocking screws. When removing the nail, leave one tibial screw in place until the nail extraction rod is threaded into the distal end of the nail. This prevents the implant from rotating while trying to engage the extraction rod.

Note: The distal calcaneal screw must be removed to allow the extraction rod to thread into the nail.

Once the extraction rod is firmly attached to the end of the nail, remove the remaining screw and then the nail by lightly backslapping the extraction rod with the slotted mallet.

Tray Layout

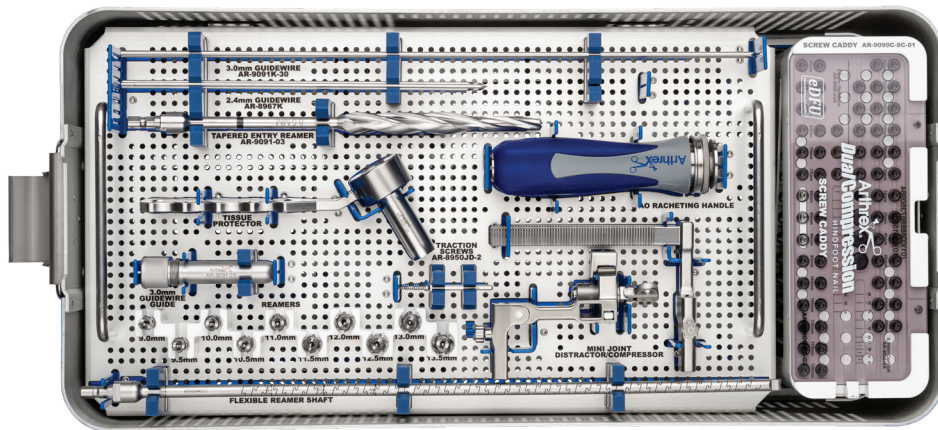

- Level 1**
- › Guidewires
- › Tapered Entry Reamer
- › Tissue Protector
- › Guidewire Guide
- › AO Ratcheting Handle
- › Reamers
- › Flexible Reamer Shaft
- › Mini Joint Compressor/Distractor
- › Traction Screws

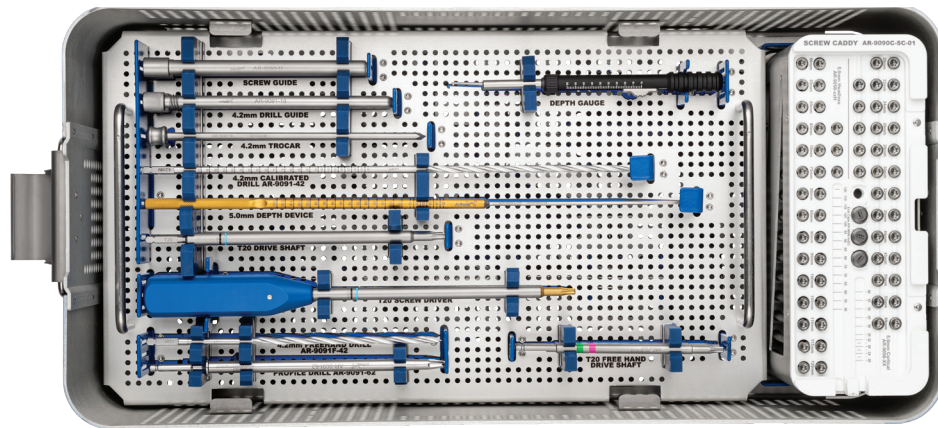

- Level 2**
- › Tissue Protector/Screw Guide
- › Drill Sleeve
- › Trocar
- › 4.2 mm Drills
- › Profile Drill
- › T20 Screwdriver and Driver Shafts
- › Depth Gauges

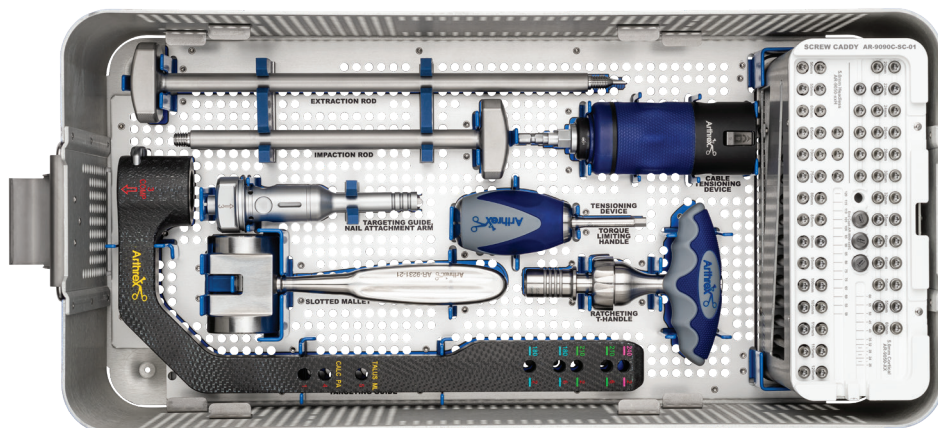

- Level 3**
- › Targeting Guide
- › Ratcheting T-Handle
- › 7/32-inch Hex Torque Limiter
- › Cable Tensioner
- › Impaction Rod
- › Nail Attachment Arm
- › Slotted Mallet
- › Extraction Rod

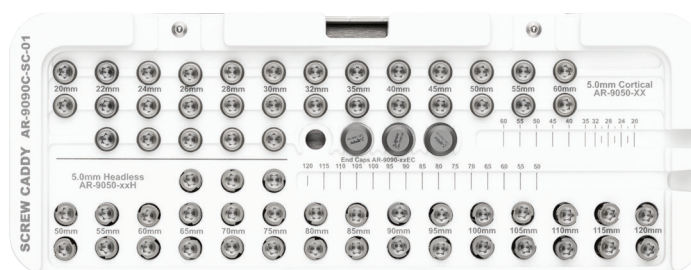

- Screw Caddy**
- › Headless Screws
- › Headed Screws
- › End Caps

Supporting Products

Biologic Augmentation Options



ArthroCell™ Viable Bone Matrix

ArthroCell matrices are osteogenic, osteoinductive, and osteoconductive that deliver a 100% human-derived product that mimics the structure of native bone, provides optimal handling, and resists irrigation. The grafts are preserved in a novel DMSO-free cryoprotectant for preservation of cells, eliminating the need to rinse or decant during graft preparation.

ArthroCell, 2.5 cc	ABS-2009-02
ArthroCell, 5.0 cc	ABS-2009-05
ArthroCell Plus allograft, 1 cc	ABS-2090-01
ArthroCell Plus allograft, 2.5 cc	ABS-2090-02
ArthroCell Plus allograft, 5.0 cc	ABS-2090-05



AlloSync™ Expand

AlloSync Expand fibers are 100% demineralized bone ideal for intraoperative handling and controlled expansion into bone voids. The unique structure of long fibers give AlloSync Expand cohesive and moldable handling characteristics that allow for expansion of demineralized bone matrix (DBM) post-implantation to improve the fill of bone voids.

AlloSync Expand, 1 cc	ABS-2017-01
AlloSync Expand, 2.5 cc	ABS-2017-02



AlloSync™ Pure Matrix

AlloSync Pure is a DBM derived from 100% allograft bone with no extrinsic carriers. Surgeons can adjust the viscosity of AlloSync Pure bone matrix to have a more flowable or putty-like consistency based on hydration ratio to readily mold into various bone voids.

AlloSync Pure, 1.0 cc	ABS-2010-01
AlloSync Pure, 2.5 cc	ABS-2010-02



Angel® System

The Angel system is the only system to provide cPRP from bone marrow aspirate (BMA) with adjustable cellular levels with its proprietary platelet sensor system.

Angel PRP system centrifuge	ABS-10060
Angel cPRP and BMA tray	ABS-10062T



BioSurge™ Cell and Bone Graft Processing System

The Arthrex BioSurge system combines the AlloSync Pure demineralized bone graft with the Angel system's proprietary technology to prepare customized platelet-rich plasma concentrate (cPRP) from BMA. Hydrated AlloSync Pure provides the optimal scaffold for cPRP from BMA, which is a rich source of platelets and nucleated and progenitor cells.²

BioSurge I System, 2.5 cc AlloSync Pure with Arthrex Angel cPRP and BMA tray	ABS-2016-01
--	-------------

Ordering Information

DualCompression Hindfoot Nail System (AR-9090S)

Hindfoot nail targeting guide	AR-9091-01
Hindfoot nail attachment arm	AR-9091-01A
Hindfoot nail attachment bolt	AR-9091-01B
Hindfoot nail cable tensioner	AR-9091-02
Reamer head, flexible, end cutting, 9.0 mm	AR-9091-04
Reamer head, flexible, 9.5 mm	AR-9091-05
Reamer head, flexible, 10 mm	AR-9091-06
Reamer head, flexible, 10.5 mm	AR-9091-07
Reamer head, flexible, 11 mm	AR-9091-08
Reamer head, flexible, 11.5 mm	AR-9091-09
Reamer head, flexible, 12 mm	AR-9091-10
Reamer head, flexible, 12.5 mm	AR-9091-11
Reamer head, flexible, 13 mm	AR-9091-12
Reamer head, flexible, 13.5 mm	AR-9091-13
Reamer head, flexible, 14 mm	AR-9091-14
Reamer head, flexible, 14.5 mm	AR-9091-15
Tissue protection sleeve, qty. 2	AR-9091-17
Drill sleeve, 4.2 mm, qty. 2	AR-9091-18
Trocar, 4.2 mm, qty. 2	AR-9091-19
Profile drill, 6.3 mm	AR-9091-62
Flexible reamer shaft, 369 mm, qty. 2	AR-9091-20
Soft tissue protection sleeve, 3 mm	AR-9091-22
Guidewire sleeve, 3.0 mm	AR-9091-23
Drive shaft, T20 hexalobe, qty. 2	AR-9091-24
Hexalobe driver, T20, qty. 2	AR-8970-03
Mini joint distractor/compressor	AR-8970JD
Screw depth-measuring device	AR-9091-25
Hex torque limiter, 7/32 in	AR-9091-26
Extraction rod	AR-9091-27
Freehand depth-measuring device, qty. 2	AR-9091-28
Impaction rod	AR-9091-31
T-handle, Hudson, ratcheting, hybrid	AR-9091-32
Handle, large, ratcheting, cannulated, AO	AR-8970RH
Screwdriver, T20 hexalobe	AR-9091-34
Mallet, slotted	AR-9231-21
DualCompression hindfoot fusion system case	AR-9090C

Implants and Disposables (AR-9090I)

Screws	
Low profile screws, cortical, Ti, 5.0 mm × 20 mm – 32 mm (2.0 mm increments)	AR-9050-20-32
Low profile screws, cortical, Ti, 5.0 mm × 35 mm – 60 mm (5.0 mm increments)	AR-9050-35-60
Headless screws, cortical, Ti, 5.0 mm × 50 mm – 120 mm (5.0 mm increments)	AR-9050-50H-120H
DualCompression Hindfoot Nails	
Hindfoot nail, 10.5 mm × 180 mm	AR-9090-01S
Hindfoot nail, 10.5 mm × 210 mm	AR-9090-02S
Hindfoot nail, 10.5 mm × 240 mm	AR-9090-03S
Hindfoot nail, 10.5 mm × 300 mm	AR-9090-04S
Hindfoot nail, 11.5 mm × 180 mm	AR-9090-05S
Hindfoot nail, 11.5 mm × 210 mm	AR-9090-06S
Hindfoot nail, 11.5 mm × 240 mm	AR-9090-07S
Hindfoot nail, 11.5 mm × 300 mm	AR-9090-08S
Hindfoot nail, 12.5 mm × 180 mm	AR-9090-09S
Hindfoot nail, 12.5 mm × 210 mm	AR-9090-10S
Hindfoot nail, 12.5 mm × 240 mm	AR-9090-11S
Hindfoot nail, 12.5 mm × 300 mm	AR-9090-12S
Nail End Caps	
DualCompression hindfoot nail end cap, standard	AR-9090-13EC
DualCompression hindfoot nail end cap, 2.5 mm	AR-9090-14EC
DualCompression hindfoot nail end cap, 5.0 mm	AR-9090-15EC
DualCompression hindfoot nail end cap, 10 mm*	AR-9090-16EC
Disposables	
Traction screw, mini joint distractor, 20 mm, qty. 2	AR-8950JD-02
Stepped reamer, 8.5 mm	AR-9091-03
Drill, calibrated, 4.2 mm, qty. 2	AR-9091-42
Hindfoot nail, cable, SS, sterile	AR-9091C-17S
Freehand drill, 4.2 mm, qty. 2	AR-9091F-42
Guidewire, ball tip, 3.0 mm × 600 mm, sterile	AR-9091BK-30S
Guidewire w/ trocar tip, 2.4 mm × 200 mm, qty. 6	AR-8967K
Guidewire w/ trocar tip, 3.0 mm × 370 mm, qty. 2	AR-9091K-30

*Special order item

References

1. Arthrex, Inc. Data on file (APT-04782G). Naples, FL; 2020.
2. Hernigou P, Mathieu G, Poignard A, Manicom O, Beaujean F, Rouard H. Percutaneous autologous bone-marrow grafting for nonunions. Surgical technique. *J Bone Joint Surg Am.* 2006;88 Suppl 1 Pt 2:322-327. doi:10.2106/JBJS.F.00203

This description of technique is provided as an educational tool and clinical aid to assist properly licensed medical professionals in the usage of specific Arthrex products. As part of this professional usage, the medical professional must use their professional judgment in making any final determinations in product usage and technique. In doing so, the medical professional should rely on their own training and experience and should conduct a thorough review of pertinent medical literature and the product's directions for use. Postoperative management is patient-specific and dependent on the treating professional's assessment. Individual results will vary and not all patients will experience the same postoperative activity level or outcomes.



Arthrex manufacturer, authorized representative, and importer information (Arthrex eIFUs)



US patent information